

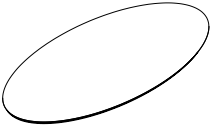

ITEM IMAGE					
QTY	WOODEN TOP - 1 PC	IRON LEGS - 2 PC	ALLEN BOLTS 25x8 mm - 19 PCs	WASHER 20x8 mm - 19 PCs	ALLEN KEY 6 mm - 1 PCs

STEP - 1

Insert legs into each other as shown in figure.

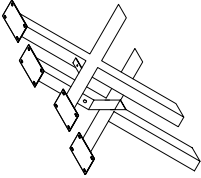
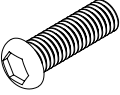
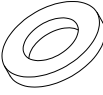

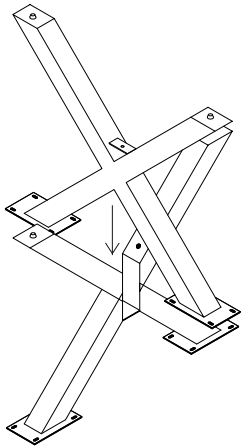
STEP - 2

Align the connecting strip with holes on legs as shown in figure below. Attach it to legs with washers and allen bolt and tighten it 50% with allen key.

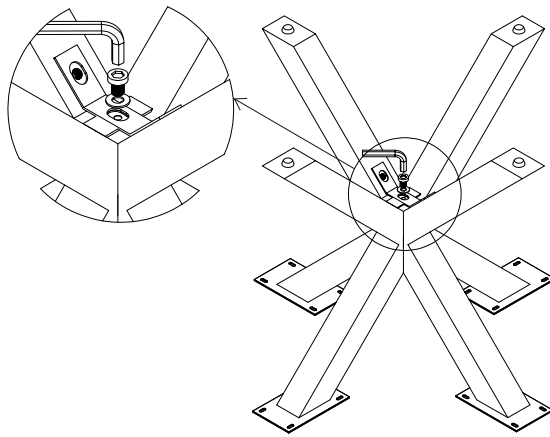

STEP - 3

Tighten the given bolts with allen key up to 50% as shown in figure.

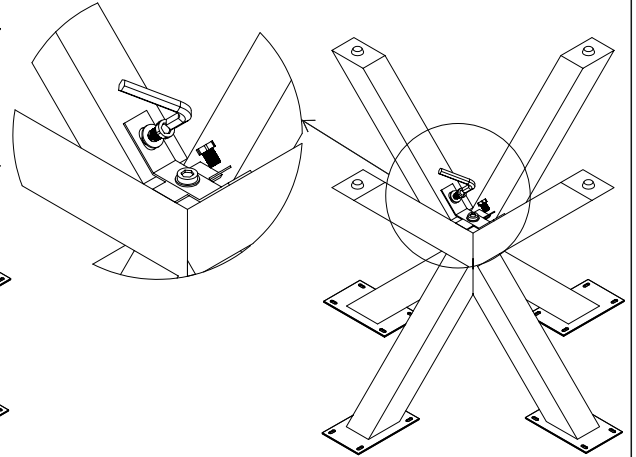

STEP - 4

Flip the legs on the ground to level them and tighten all the bolts 100% with allen key.

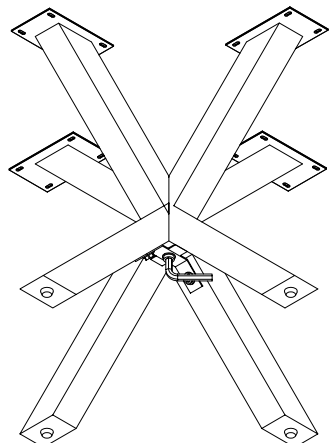

STEP - 5

Flip the top and put it on the floor and align the holes on the legs with holes on the top, Attach them with washers and allen bolts and tighten them with allen key.

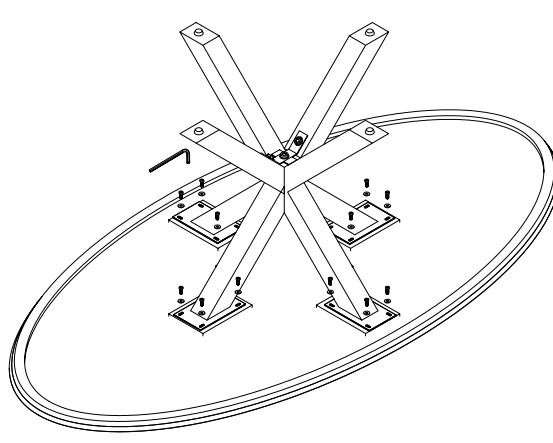

FINAL STEP

Adjust the wobbling of table with the help of attached leveler under the legs by twisting as show in figure.

