

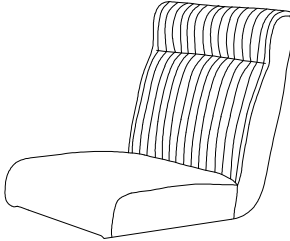

	<p>Ax1</p> 	<p>Bx1</p> 	
<p>Cx2</p>  <p>M6*50</p>	<p>Dx2</p>  <p>M6*45</p>	<p>Ex2</p>  <p>M6*14*1</p>	<p>Fx1</p>  <p>M4</p>

## STEP 1

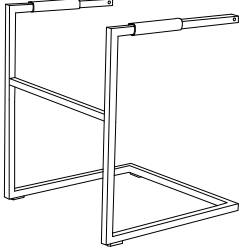

## STEP 2

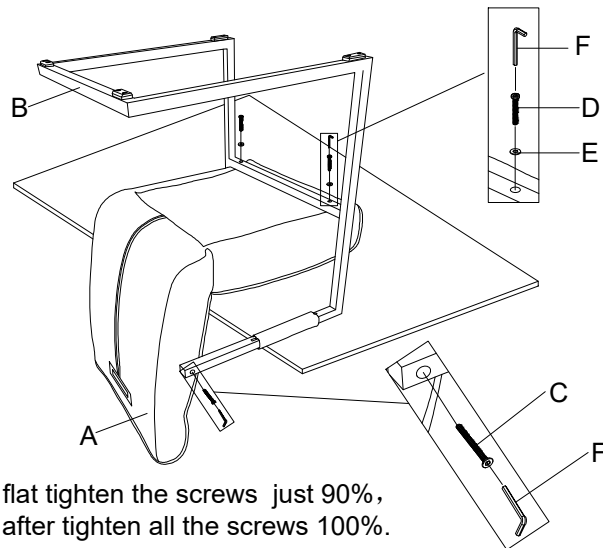